

ハイキャスコンピューター配置図

コネクタ端子配置図のみかた

コネクタ

コード

確認する方向

上段

下段

→右

- コードの選別は必ずコネクタをコード側からみた方向で行ってください。
- 車両によってはコンピューターが内張り(カバー)の中にあります。その場合、内張りを外し作業を行ってください。
- コネクタやコンピューターは、カバーをかぶっていることがあります。作業時はカバーを外してください。
- 配線を無理に引っばらないでください。故障の原因となります。

R32

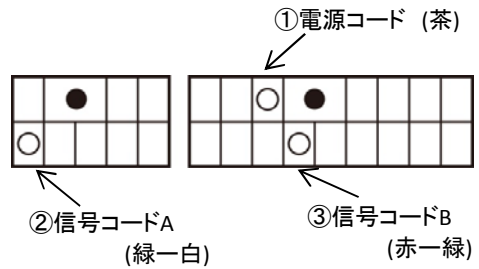
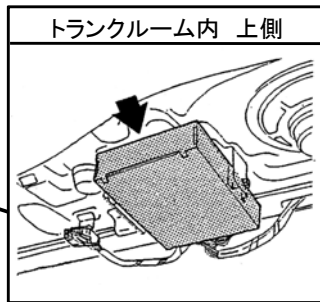
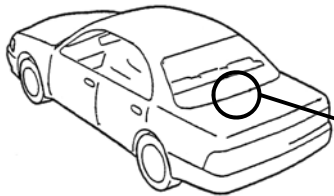

R33

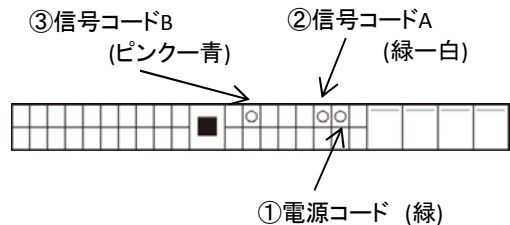
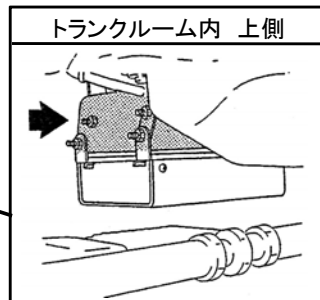
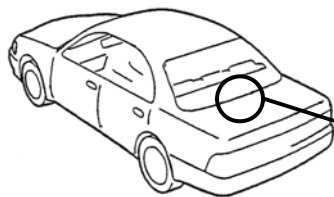

A31

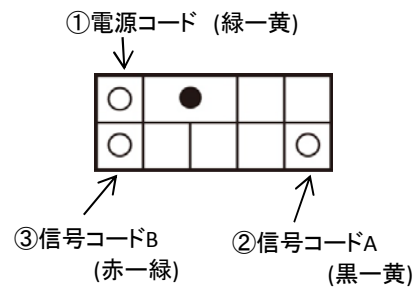
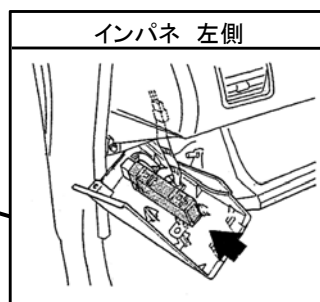
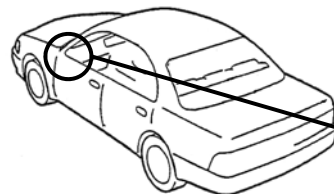

Z32

■マイナー前 (～93.9)

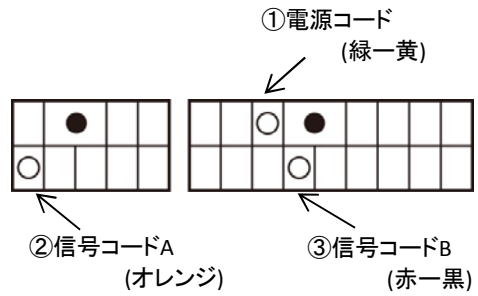
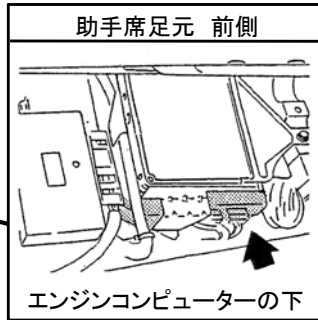
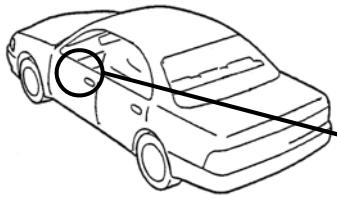

■マイナー後 (93.9～)
※2シーター

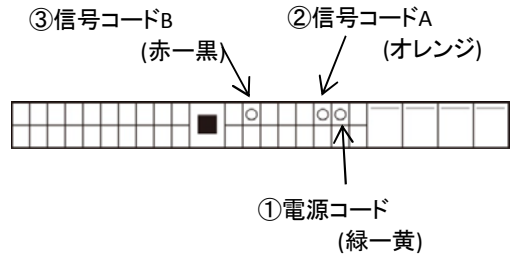
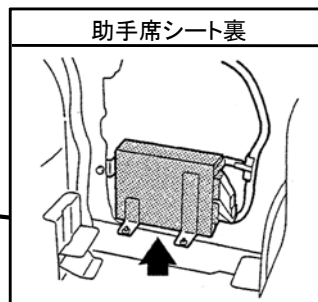
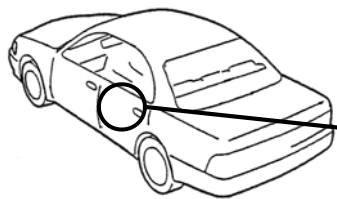

■マイナー後 (93.9～)
※2/2

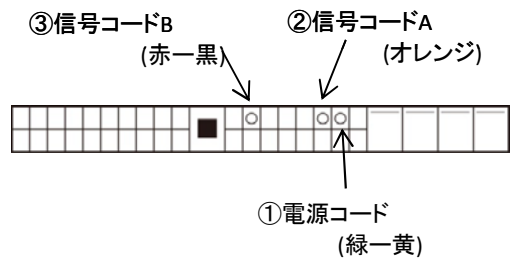
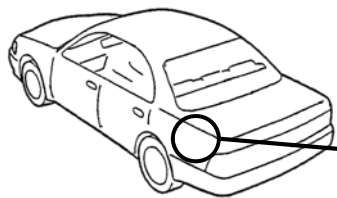

Y32

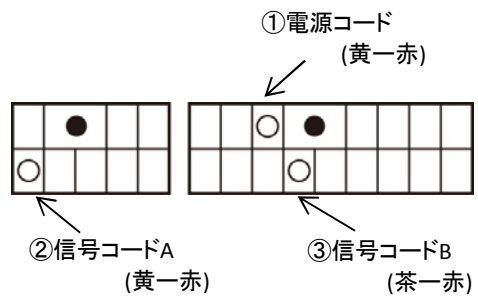
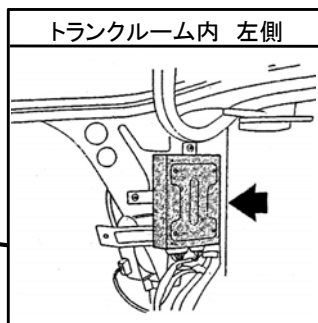
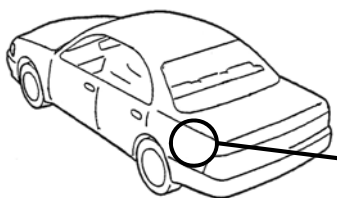

Y33

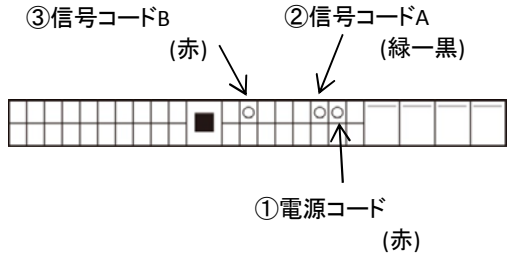
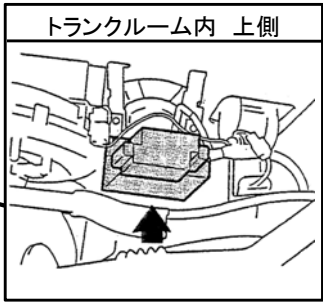
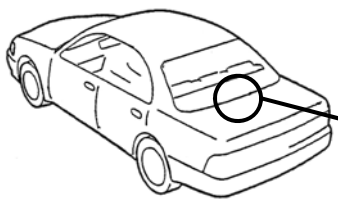

C33

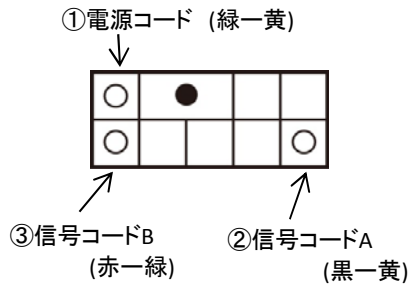
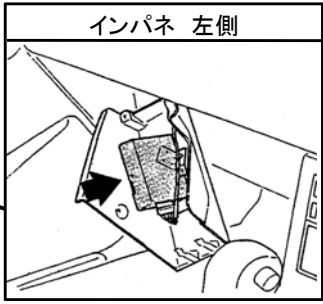
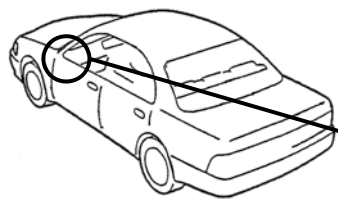

C34

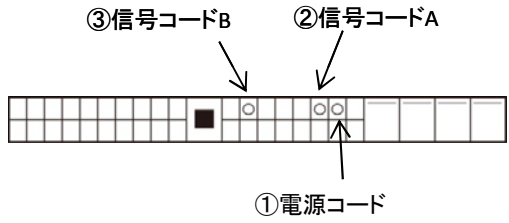
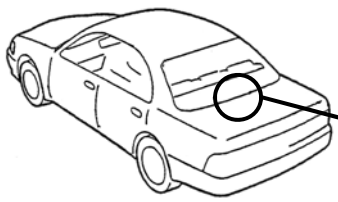

ER34

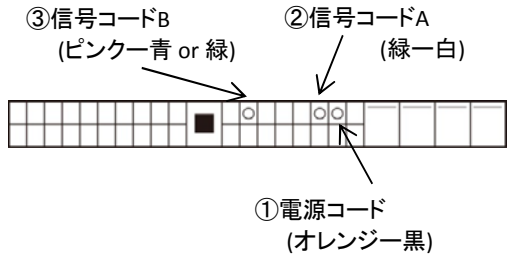
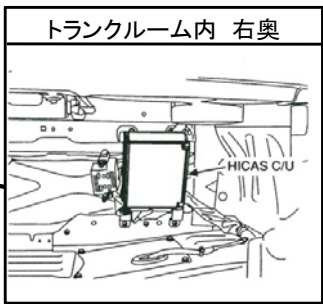
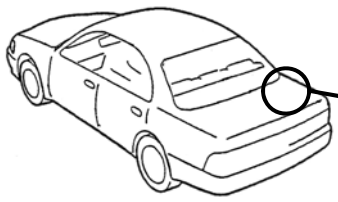

HICAS COMPUTER INFORMATION

How to read the Connector Pinouts

Connector

Wires

Direction of view.

Upper

Lower

→Right

- When working with the wires, facing the connector where the wires go into it (from the back).
- Some vehicles computers have a protective cover or lining. If so, please remove the cover or lining.
- Both the Connector and the Computer may have a cover, please remove the cover when working.
- Please do not pull on the wires with force, to prevent any unwanted damages.

R32

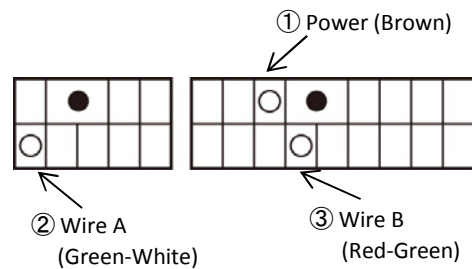
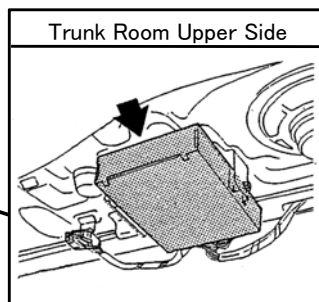
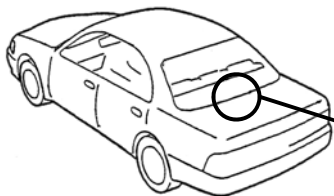

R33

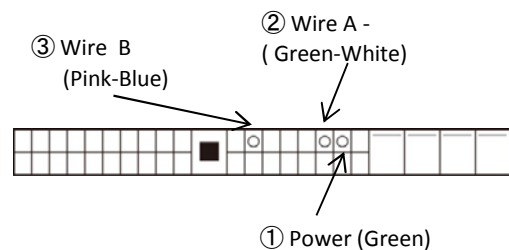
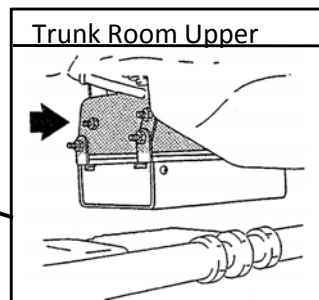
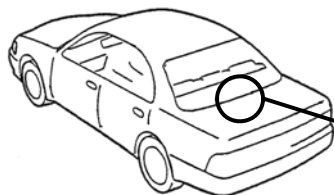

A31

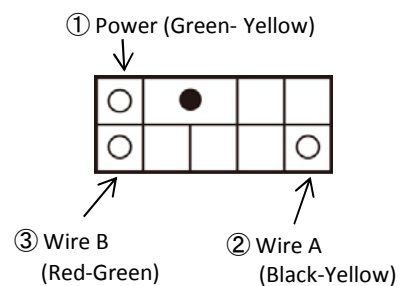
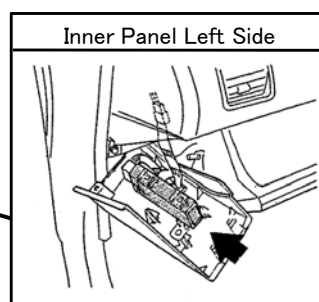
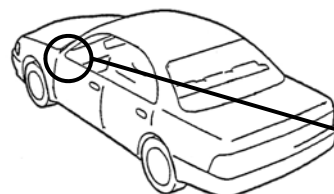

S13, RS13

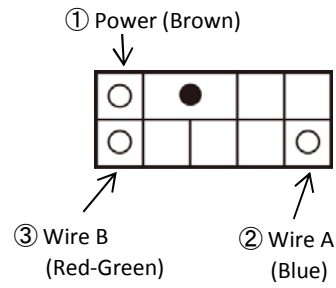
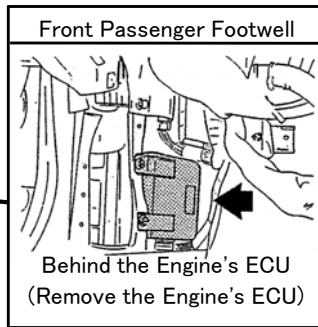
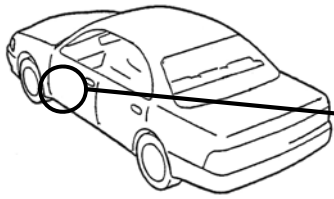

PS13, RPS13

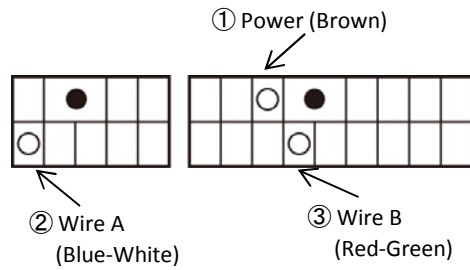
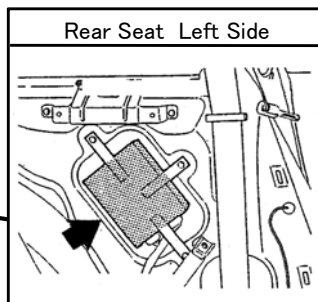
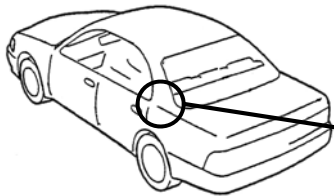

S14

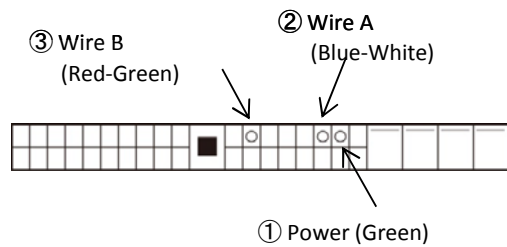
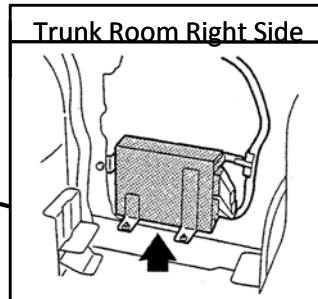
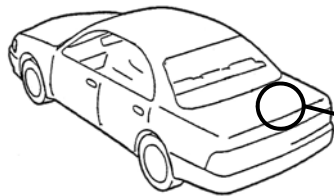

S15

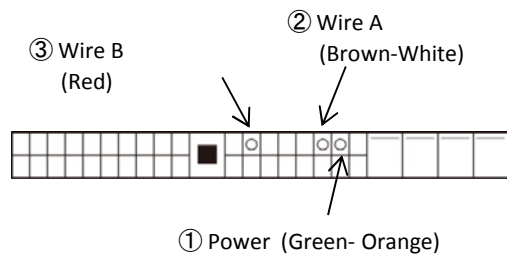
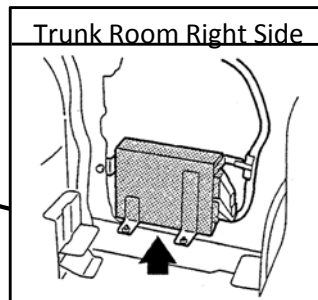
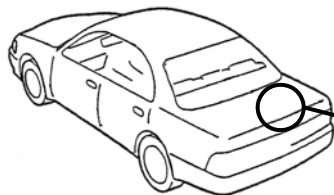

Z32

■ Early Model (~93.9)

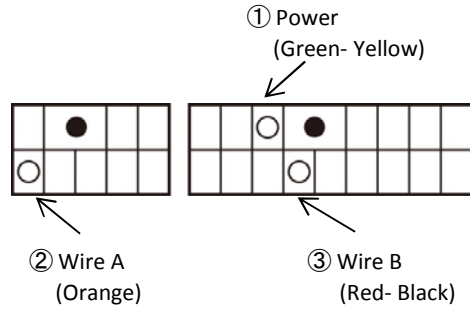
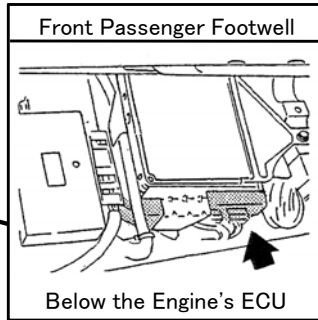
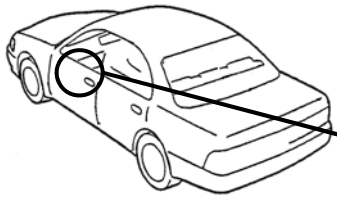

■ Late Model (93.9~)
※2 Seater

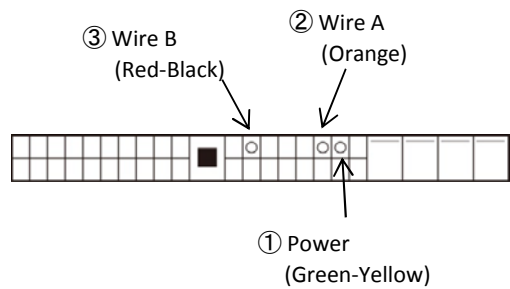
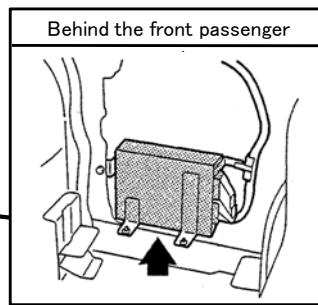
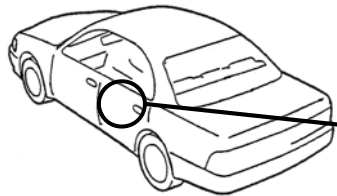

■ Late Model (93.9~)
※2/2

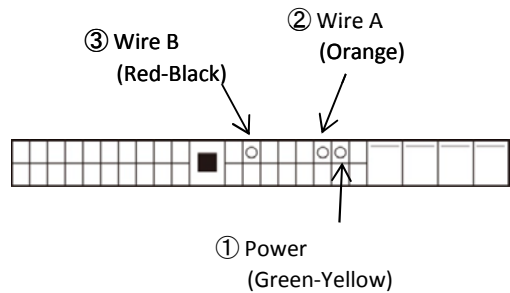
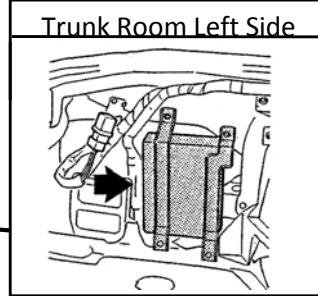
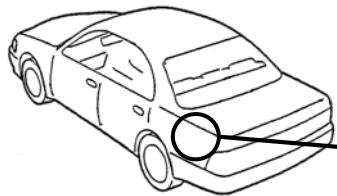

Y32

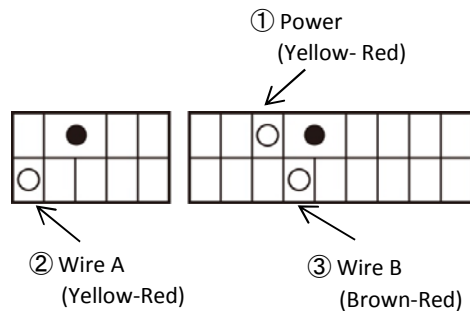
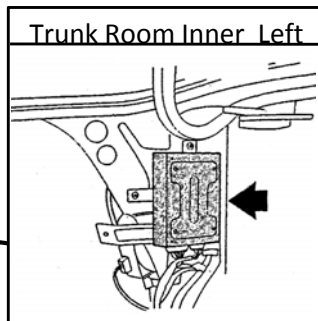
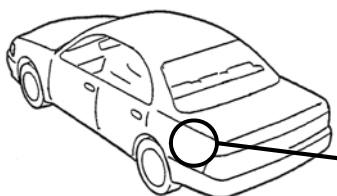

Y33

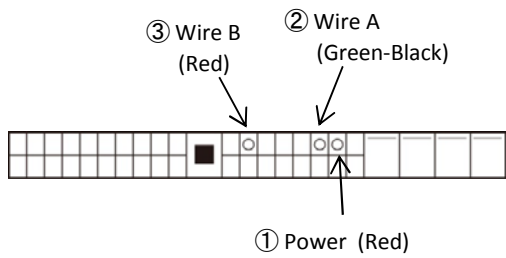
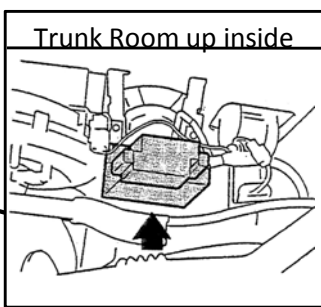
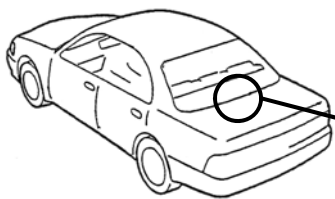

C33

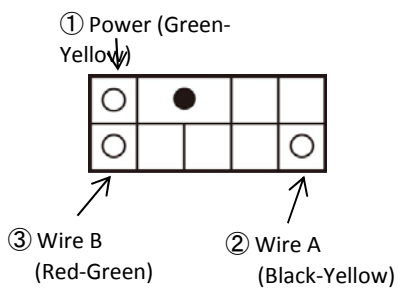
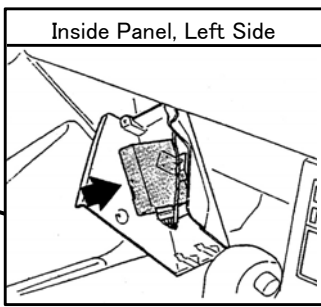
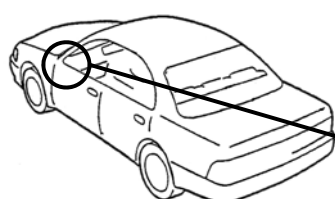

C34

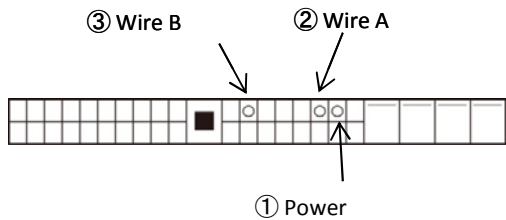
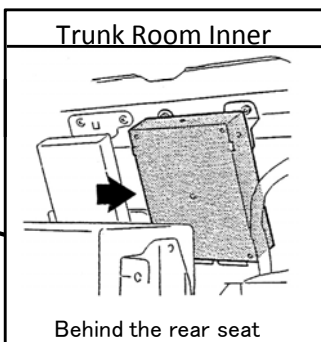
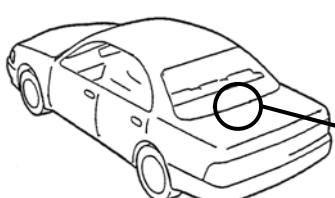

ER34

